

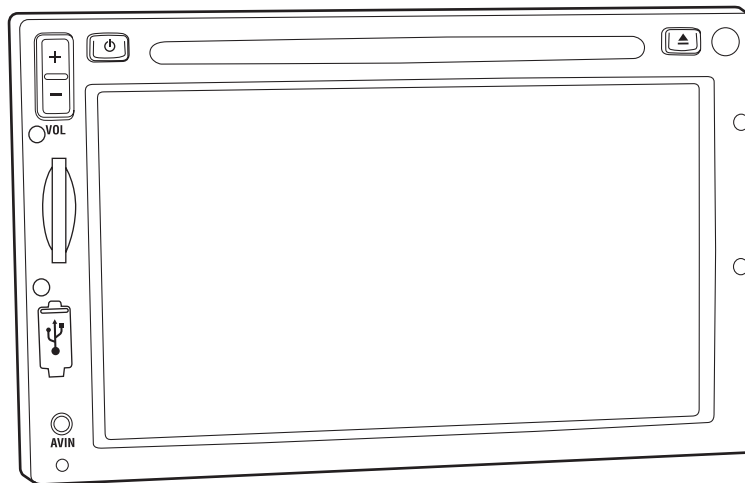

# Operation and Installation Manual

---



**M1-LCD**  
AM/FM/WB Stereo Receiver with CD/DVD Player  
and Touch Screen Controls

## Introduction

Please carefully read all of the information in this manual. Familiarity with operation and installation procedures will help you obtain the best possible performance from your new AM/FM/WB Stereo Receiver and CD/DVD Player with Touch Screen Controls.

**WARNING!** To prevent fire or electrical shock hazard, do not expose this product to moisture or remove its cover or bottom screws. No user-serviceable parts inside. Refer servicing to qualified personnel.

## Index

Warnings and Cautions .....	3
Basics .....	4
Button Locations and Functions .....	5
Remote Control Button Locations and Functions .....	5-6
<b>System Setup</b>	
Beep Tone .....	6
Region .....	7
Background Color .....	7
Front Camera .....	7
Startup Volume .....	7
RDS .....	7
Standby Clock .....	7
<b>Home Row</b>	
Settings .....	7
Sound .....	8
Monitor .....	8
Time .....	8-9
Display .....	9
Dim .....	10
Mute .....	10
Back .....	10
<b>Sound Controls</b> .....	11-12
<b>RADIO and WEATHER</b>	
AM/FM Radio Operations .....	13-15
Weather Band Radio Operations .....	16
<b>DISC, USB and SD CARD</b>	
Disc Warnings .....	17
CD Operation (Compact Disc) .....	17-19
MP3 Operation (DISC, USB and SD CARD) .....	19-23
DVD Operation .....	24-26
DVD Setup Menu .....	27
<b>SATELLITE</b>	
Sirius Satellite Radio Setup .....	28
Sirius Satellite Radio Operation .....	29-33
<b>CD CHANGER</b>	
CD Changer Operation .....	34-35
<b>AUX</b>	
Auxiliary Audio/Video Inputs Operation .....	36
<b>CAMERA</b>	
Camera Operation .....	37
<b>IPOD</b>	
IPOD Operation .....	38-39
<b>NAVIGATION</b>	
Navigation Operation .....	40
Installation .....	41
Speaker Connections .....	42
Input Connections .....	43-45
Camera Connections .....	46
Reset Button .....	47
Replaceable Fuse .....	47
Warranty .....	48

## Warnings

- **The driver should neither watch the display nor operate the system while driving.**  
Watching the display or operating the system will distract the driver from looking ahead of the vehicle and can cause accidents. **Always stop the vehicle in a safe location and use the parking brake before watching the display or operating the system.** In some states and countries, passengers are also prohibited from watching the display.
- Never install the product in a location where it interferes with your field of vision.
- This unit has a cooling fan to decrease the internal temperature. Do not mount the unit in a place where the cooling fan on the unit is blocked. Blocking these openings will inhibit the cooling of the internal temperature and result in damage to the unit.
- Use the proper power supply. This product is designed for operation with a negative grounded 12V DC battery system. Never operate this product with other battery systems, especially a 24V DC battery system. If the product is used with the improper system it may cause a fire or an accident.
- **This product must be installed and used in accordance with this manual. Any alterations to this product that enables it to be used in any way other than intended or designed could distract the driver and result in an accident causing injury or death. Magnadyne Corporation disclaims any and all liability that may result from failure to install and operate in any other manner in which this unit was intended.**
- Do not disassemble, modify the unit or attempt to repair the product yourself. If the product needs to be repaired, consult your dealer.
- Do not install the unit in a place exposed to direct sunlight or excessive heat or humidity. Avoid places with too much dust or the possibility of water splashing.
- **Backing Up Your Vehicle**  
**Do not backup your vehicle while looking at the monitor. Always look in the direction of your vehicle's motion. Use the monitor only as an aid in safety confirmation.** The actual distance may be different than it appears in the monitor. The range of the image in the monitor is limited. Always be aware that blind spots may exist and not appear at all times on your monitor.

**The product is intended to assist in safe driving and allows the driver to have a broader field of vision during backup. You, as the driver, are solely responsible for the safe operation of your vehicle and the safety of your passengers and pedestrians, and abiding all state and local traffic regulations. Do not use any features of this system to the extent it distracts you from safe driving. Your first priority while driving should always be the safe operation of your vehicle. Magnadyne will not accept any responsibility whatsoever for accidents and/or injuries resulting from failure to observe these precautions or safety instructions.**

## Caution

- FCC REGULATIONS STATE THAT ANY UNAUTHORIZED CHANGES OR MODIFICATIONS TO THIS EQUIPMENT MAY VOID THE USER'S AUTHORITY TO OPERATE IT.
- TO REDUCE THE RISK OF FIRE OR ELECTRIC SHOCK, DO NOT EXPOSE THIS EQUIPMENT TO RAIN OR MOISTURE.
- THIS DEVICE IS INTENDED FOR CONTINUOUS OPERATION.
- TO REDUCE THE RISK OF FIRE OR ELECTRIC SHOCK AND ANNOYING INTERFERENCE, USE ONLY THE RECOMMENDED ACCESSORIES.

## Liquid Crystal Panel

- Any harsh impacts may damage the liquid crystal panel.
- Usage temperature range: 32°F to 104°F. When the temperature is very cold or very hot, the image may not appear clearly or may move slowly. Also, movement of the image may seem to be out of synchronization or the image quality may decline in such environments. Note that this is not a malfunction or problem.
- Sudden changes in the temperature inside the vehicle such as those which occur immediately after the vehicle's air conditioner or heater has been turned on may cause the inside of the liquid crystal panel to cloud over due to water vapor or it may cause condensation (droplets of water) to form and, as a result, the panel may not work properly. Do not use the unit while these symptoms are evident. Instead, leave the unit standing for about an hour, and then resume or start use.
- If the screen of this unit is dirty, wipe the dirt off with a cloth moistened with a mild cleaner. Note: Applying spray cleaner directly to the unit may affect its mechanical parts or cause an electrical shock. Wiping the screen with an abrasive cloth or using a volatile liquid such as thinner or alcohol may scratch or damage the surface of the screen.

## Basics

The M1-LCD screen has 3 specific areas: Display area, Source Selection area and Home Row area. Familiarizing yourself with the 3 specific areas will help you obtain the best performance from the M1-LCD.

### Display Area:

The display area is not touch activated, it only displays information. The information displayed includes:

1. Source: Orients the user to which source is being used: Radio, Disc, Satellite, etc.
2. Source Information: Displays secondary information that relates to the source.  
For example: In the radio mode, the station number will be displayed in this area.
3. Volume Level.
4. Clock.
5. Inserted Disc Icon: If a disc is inserted into the unit the inserted disc icon will be displayed.

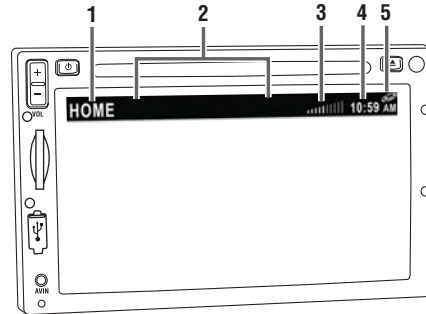

### Source Selection Area:

The source selection area is touch activated. Use your finger to select the desired source.

**Note 1:** When the source is selected the button will become highlighted and the unit will switch to the selected source's screen.

**Note 2:** When the text is black the source is not available for selection.

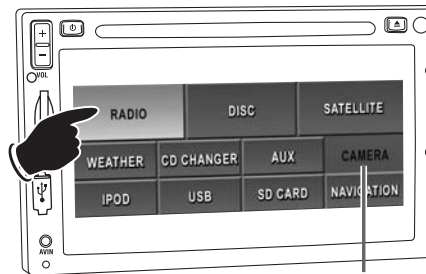

Source Not Available

### Home Row Area:

The home row area is touch activated. Use your finger to select. These buttons include:

**Home:** Pressing this button returns the unit back to the source selection screen.

**Settings:** Pressing this button activates a secondary screen containing buttons to change settings for Sound, Monitor and Time.

**Display:** On some source screens, pressing this button displays secondary information.

**DIM On:** Adjusts the screen's illumination.

**Mute:** Mutes the volume level.

**Back:** Sometimes Back appears as a button to select a previous screen.

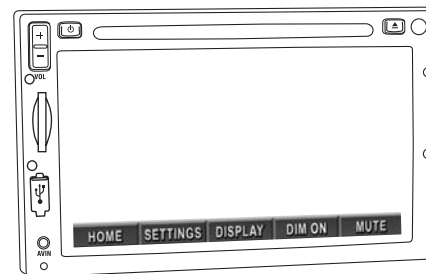



## Button Locations and Functions

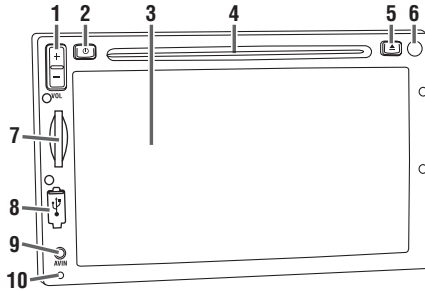

- 1. Volume Button:** Push (+) to increase or (-) to decrease the volume level.
- 2. Power On/Off Button:** Press to turn the unit On or Off.
- 3. LCD Display:** Touch to interact with the display screen.
- 4. CD Slot:** To play a CD/DVD, insert a disc into the slot with the label facing up.
- 5. Eject Button:** Press to eject a disc.
- 6. Infrared Eye:** Receives the signals from the remote control.
- 7. SD Card Slot:** Insert the SD card to play recorded music data.  
**Notes:** This unit may not play all SD cards. The manufacturer of this unit is not responsible for any data loss. We suggest you back up your data.
- 8. USB Input:** Plug in your USB device. "USB" will appear in the display.  
**Note:** This unit may not function with all MP3 players. The M1-LCD will control the USB audio device. (See "USB Operation" for more details).
- 9. Audio/Video Input Jack:** Plug in a device with a 3.5mm audio/video input plug. The M1-LCD will not control the device, it just allows the audio/video to be played through the system.
- 10. Reset Button:** Press the reset button if the unit freezes up or does not function correctly.

## Remote Control Button Locations and Functions

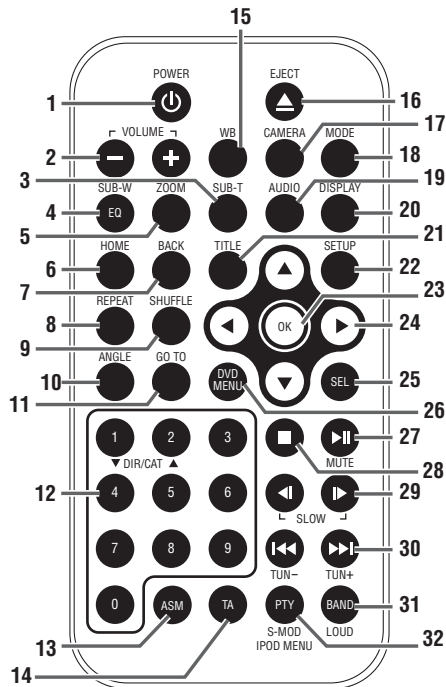

- 1. Power On/Off:** Turn the unit On or Off.
- 2. Volume:** Increase (+) or decrease (-) the volume level.
- 3. Subtitle (SUB-T):** Accesses DVD's subtitle languages.
- 4. Equalizer (EQ):** Choose between preset sound equalization settings. Press and hold to turn the subwoofer On and Off.
- 5. Zoom:** Enlarges or reduces the size of DVD picture.
- 6. Home:** Return unit back to the main source screen.
- 7. Back:** Selects previous screen.
- 8. Repeat:** Repeats play of chapters, titles, tracks and discs.
- 9. Shuffle:** Plays all the tracks on the CD in random order.
- 10. Angle:** Changes the view angle on multi-angle DVD discs.
- 11. Go to:** Use in conjunction with the numeric keypad to skip to the desired chapter.

## Remote Control Button Locations and Functions (Continued)

- 12. Numeric Keypad:** Inputs the corresponding number.
- 13. Automatic Station Memory (ASM):** Press and hold for automatic station memory storing. Press and release for scanning memorized stations.
- 14. Traffic Announcement (TA):** Activates the traffic announcement function. (See the Radio Operations section for more information).
- 15. Weather Band (WB):** Press for direct access to the weather band radio.
- 16. Eject:** Ejects the loaded disc.
- 17. Camera:** Press to change the source to camera mode.
- 18. Mode:** Scrolls through the available sources.
- 19. Audio:** Changes the language on multi-language DVD discs.
- 20. Display:** Displays source information.
- 21. Title:** Displays the title menu that is stored on the DVD disc.
- 22. Setup:** Access the Bass, Treble, Balance, Fader and Subwoofer controls.
- 23. Ok:** Confirms the selected item.
- 24. Cursor:** Moves feature selection up, down, left or right.
- 25. Select (SEL):** Accesses the Sound menu.
- 26. DVD/Menu:** Displays the DVD menu.
- 27. Play/Pause:** Starts and pauses disc play.
- 28. Stop:** Stops disc play.
- 29. Slow Motion:** Slow motion forward or reverses playback of DVD disc.
- 30. Tune/Track/Chapter:**
  - Radio:** Press and the tuner will scan to the next strong station and stop. Press and hold until "MANUAL" appears in the display then release. Then press again until the desired radio station is tuned-in.
  - CD:** Press to change to a lower or higher track.
  - DVD:** Press to change to a lower or higher chapter.
- 31. Enter/Band and Loud Button:**
  - Radio:** Selects AM1, AM2, FM1, FM2 and FM3 radio bands.
  - Loudness:** Press and hold button until "LOUD" appears in the display to boost high and low tones at low volume levels. To deactivate, press and hold again until "LOUD OFF" appears in the display.
  - IPOD Mode:** See "IPOD Operation" for more information.
- 29. Program Type (PTY):** Activates the PTY screen which scans FM radio stations according to program type.

## System Setup

System Setup provides special settings to fine-tune the user experience. **Press and hold the power button for more than 10 seconds.** The System setup display will appear. Select each item you wish to adjust by touching the item button. Touch the ►► or ◀◀ arrow button to change the settings. Press the back button to return to the previous screen.

### Beep Tone:

When the buttons are touched, the unit will emit a beep. To change this feature press the **BEEP TONE** button which will highlight this feature then touch the ►► or ◀◀ buttons to turn the beep tone on or off.

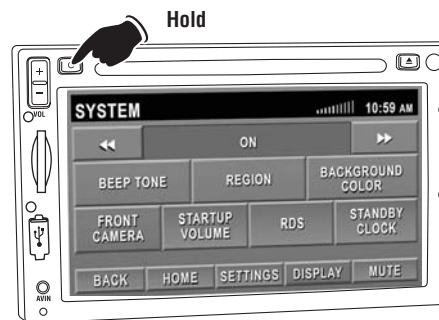

## System Setup (Continued)

### Region:

The region button changes the tuner's configuration so that it can receive frequencies from different regions. To change the region, press the **REGION** button then use the **▶▶** or **◀◀** to select different AM/FM tuning systems. **The default setting is U.S.A.**

### Background Color:

The Background Color button allows you to change the background color of the screen. To change the background color press the **BACKGROUND COLOR** button then use the **▶▶** or **◀◀** to select from GREY, GREEN, BLUE or AMBER.

### Front Camera:

If the vehicle has a front camera this feature will need to be activated (ON). The default setting is OFF. To turn on this feature press the **FRONT CAMERA** button then use the **▶▶** or **◀◀** to turn this feature on ON. When the Camera source screen is selected the front camera will be available for viewing.

### Startup Volume:

The startup volume setting controls the initial volume level each time the unit is turned on. The default setting is 12. To adjust this feature press the **STARTUP VOLUME** button then use the **▶▶** or **◀◀** to adjust the startup volume level.

### RDS:

The RDS button (radio station data system) displays information such as the station's name or artist - title/song. The default setting is On. To turn off this feature, press the **RDS** button then use the **▶▶** or **◀◀** to select OFF.

**Note:** If the RDS system is turned off, the Traffic and PTY buttons will not function.

### Standby Clock:

This feature displays a clock on the screen when the ignition key is on but the M1-LCD unit is off. The default setting is on. To turn off this feature, press the **STANDBY CLOCK** button then use the **▶▶** or **◀◀** to select OFF.

## Home Row

### Home Button:

Pressing the **HOME** button returns the unit back to the source selection screen from any screen.

**Note:** When the **HOME** button is selected, the screen will switch to the source selection screen but continue to play the previous selected source until a new source is selected.



### Settings Button:

Pressing the **SETTINGS** button brings you to a secondary screen containing buttons to change: Sound, Monitor and Time.



## Home Row (Continued)

### Settings Button (continued):

#### Sound Button

##### Sound Button:

Press the **SOUND** button to activate the sound adjustment screen.

See “Sound Controls” (Page 11) for operation instructions.



#### Monitor Button

##### Monitor Button:

Press the **MONITOR** button to activate the monitor adjustment screen. Then select from brightness, color, contrast or tint by touching the corresponding button. Use the - and + buttons to adjust the monitor to achieve the desired picture.

**Brightness:** Press the **BRIGHTNESS** button to adjust the amount of white light in the image.

**Color:** Press the **COLOR** button to adjust the amount of color saturation in the image.

**Contrast:** Press the **CONTRAST** button to adjust the difference between the lightest and darkest portions of the image.

**Tint:** Press the **TINT** button to adjust the overall color of the image of the screen by changing the intensity of the primary green and primary red colors.

Press the **HOME** button after adjustment.



#### Time Button

##### Time Button (Setting the Clock):

Press the **TIME** button to activate the clock adjustment screen.



## Home Row (Continued)

### Settings Button (continued):

#### Time Button

##### 1. 12 or 24-Hour Time Format:

Press the **TIME FORMAT** button to select the time format. For a 12-hour clock (am and pm) press the **TIME FORMAT** button until either AM or PM appear in the display. For a 24-hour clock (military time) press the **TIME FORMAT** button until neither AM or PM appear in the display.



12 or 24 Hour Indicator

##### 2. Selecting Hours or Minutes:

Press the **▶** button to select the hours or minutes. Hours has been selected when the hour number flashes.

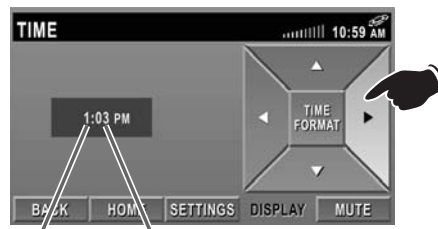

Hours Minutes

##### 3. Adjusting the Hours or Minutes:

Press the **▼** or **▲** button until the correct "Hours" appear in the display.

**Note:** When setting the 12-hour clock, make sure to select the correct AM or PM indicator.

Repeat the same procedure to adjust the minutes. When finished press **HOME** or **BACK** button.



### Display Button:

Pressing the **DISPLAY** button when available will display additional source information in the information area.



## Home Row (Continued)

### Dim Button:

Pressing the **DIM OFF** button will dim the display. The button will now be highlighted and **DIM ON** will now appear on the button. Pressing the button again will return the display to normal brightness.



### Mute Button:

Pressing the **Mute** button will mute the volume level. "MUTE" will flash in the information area. Pressing the **MUTE** button again will restore the volume level.

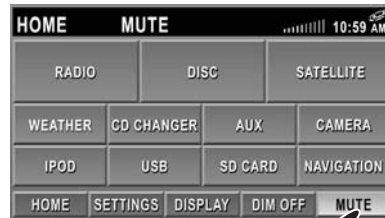

### Back Button:

In select screens, the **BACK** button will appear in the Home Row. Pressing this button will select the previous screen.



## Sound Controls

### Volume:

Increase the volume by pressing the + side of the button.

Decrease the volume by pressing the - side of the button.

**Note:** See Startup Volume (page 7) on how to adjust the initial startup volume level.

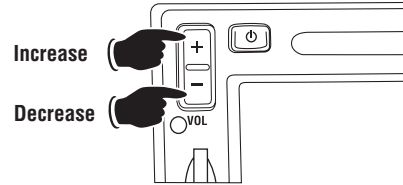

Volume Level Indicators

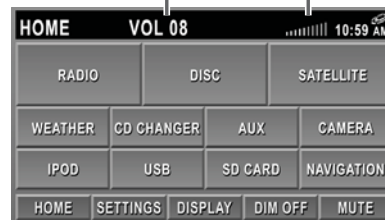

### Bass, Treble, Balance and Fader Controls:

To access the Bass, Treble, Balance and Fader buttons, press the **SETTINGS** button in the home row then press the **SOUND** button.

Touch the button to activate the desired adjustment control. When the item is selected the button will become highlighted. Press the - button to decrease the output and press the + button to increase the output of Bass and Treble. The yellow bar will move to indicate the adjustment. The highlighted bar in the middle of the scale indicates a neutral position.

**Note 1:** Balance button adjusts the amount of sound output to the left and right speakers.

**Note 2:** Fader button adjusts the amount of sound output to the front and rear speakers.

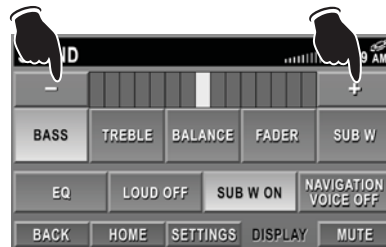

### Equalizer (EQ):

To access the EQ button, press the **SETTINGS** button in the home row then press the **SOUND** button.

Touch the **EQ** button to choose between the pre-set equalizer settings: DSP OFF, FLAT, CLASSICS, POP M, ROCK M and JAZZ as indicated in the display area.

**Note:** "DSP OFF" setting reverts Bass and Treble back to the last manually adjusted settings.

Equalizer Setting

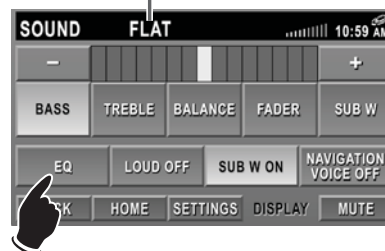

## Sound Controls (Continued)

### Loudness:

To access the Loud button, press the **SETTINGS** button in the home row then press the **SOUND** button.

Touching the **LOUD OFF** button will boost high and low tones at lower volume levels. When the item is selected, the button will become highlighted and **LOUD ON** will appear on the button. "LOUD" also appears in the display area. To deselect, touch the **LOUD ON** button.

### Loud Indicator

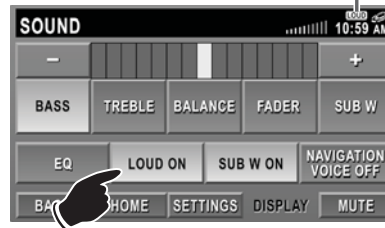

### Subwoofer Output:

To access the Subwoofer button, press the **SETTINGS** button in the home row then press the **SOUND** button.

To turn the subwoofer effect On or Off, touch the **SUB W OFF/ON** button.

When the subwoofer is turned On the output level can be adjusted. Touch the **SUB W** button and use the + and - to adjust the subwoofer output.

**Note 1:** When the subwoofer is turned Off, the output level can not be adjusted as indicated by the deactivated **SUB W** button.

**Note 2:** Your vehicle may not be equipped with a subwoofer, therefore this button will be non-functional.

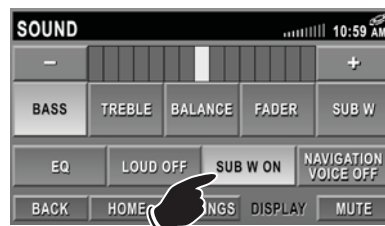

### Navigation Voice Control:

To access the Navigation Voice button, press the **SETTINGS** button in the home row then press the **SOUND** button.

Turn the navigation voice on or off by touching the **NAVIGATION VOICE OFF/ON** button.

**Note:** If an optional navigation unit is not connected to the M1-LCD, this button has no effect.

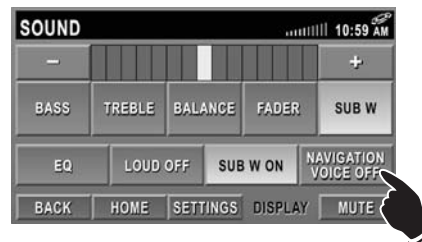

### Mute Button:

Pressing the **MUTE** button will partially mute the volume level. "MUTE" will flash in the information area. Pressing the **Mute** button again will restore the volume level.

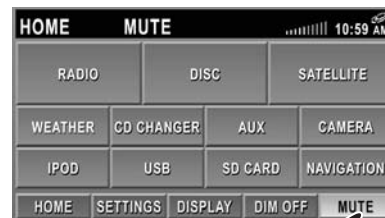



## Radio Operation

### Power On/Off:

Press the  button to turn the unit On.

### Selecting the Radio Source:

Touch the **HOME** button to activate the source selection screen. Touch the **RADIO** button to enter the radio operation screen.

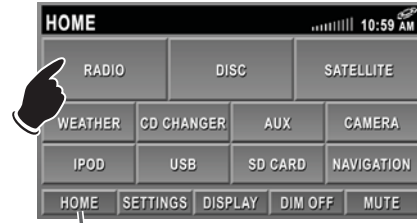

Home Button



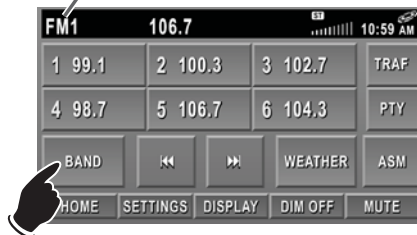

### Selecting the AM or FM Band:

Press the **BAND** button repeatedly and select from AM1, AM2, FM1, FM2 or FM3.

### Band Indicator



### Manually Tuning in a Radio Station:

Press and hold either the  or  button until "MANUAL" appears in the display, then release. Then press the  or  button until the desired radio station appears in the display.



**Note:** The unit will automatically switch from FM Mono to FM Stereo when the signal strength increases to a stereo level. If the stereo signal should become weak, the unit will switch back to Mono. FM stereo reception is indicated when the "ST" appears in the display.



Lower Frequency

Higher Frequency

### Tuning in a Radio Station Using Seek:

Press either the  or  button and the tuner will scan to the next strong station, then it will stop seeking and start playing.

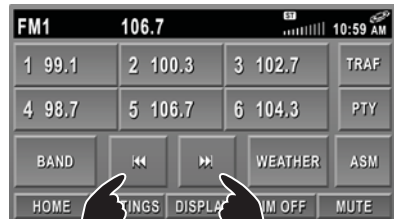

Lower Frequency

Higher Frequency

## Radio Operation (Continued)

### Programming Radio Stations:

1. Press the **BAND** button to select from the AM1, AM2, FM1, FM2 or FM3 radio band.
2. Tune in the desired radio station.
3. To program the station, press and hold one of the six **Radio Station Recall** buttons until you hear a beep. The Radio Station Recall button will now contain the programmed radio station frequency.
4. The Programmed Radio Station Recall Indicator will appear in the display.

### Memorized Radio Station Indicator

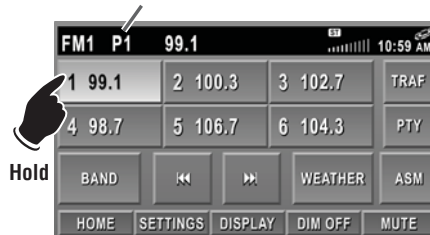

### Recalling Programmed Radio Stations:

1. Press the **BAND** button to select from the AM1, AM2, FM1, FM2 or FM3 radio band.
2. Press and release one of the six **Radio Station Recall** buttons to select the programmed radio station.

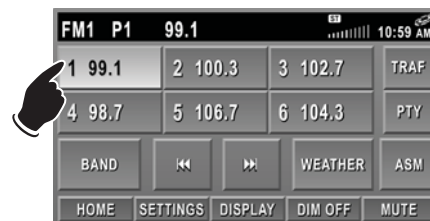

### Automatically Store Radio Stations:

1. Press the **BAND** button to select from the AM1, AM2, FM1, FM2 or FM3 radio band.
2. Press and hold the **AMS** button until "SEARCH" appears in the display. The tuner will search for the strongest stations and store them into memory. The new stations will replace stations that were previously stored in the current band.  
**Note:** After the new stations are stored into memory, the tuner will start scanning the newly programmed stations.
3. When a desired station is reached, press the **ASM** button to stop the scanning.

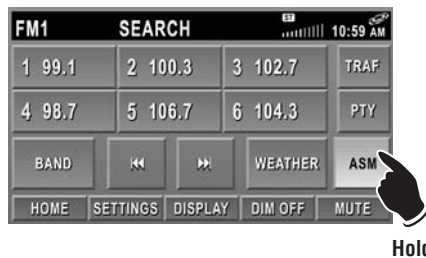

### Scanning Stored Radio Stations:

1. Press the **TUNE** knob to select from the AM1, AM2, F1, F2 or F3 radio band.
2. Press the **ASM** button and the tuner will scan for preset stations stored in the current band and pause for 5 seconds at each station. When a desired station is reached, press the **ASM** button again to stop scanning.



## Radio Operation (Continued)

### Scanning for FM Radio Stations According to Program Type (PTY):

1. Press the **BAND** button to select from the FM1, FM2 or FM3 radio band.
2. Press the **PTY** button to display the program type screen.
3. Press the **▲** or **▼** button to select the desired program type (PTY) (Example: News, Information, Sports, etc.). The selected program type will be highlighted.
4. Press the **ENTER** button to search a station with the selected program type (PTY). Once a station has been found it will automatically start playing.
5. To search for another station in the same PTY category press either the **◀◀** or **▶▶** button.

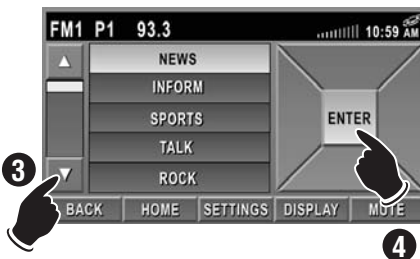
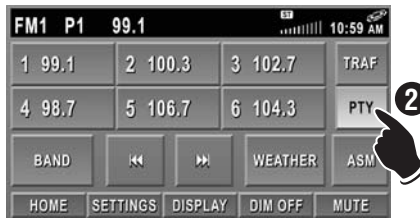

### Scanning for FM Radio Stations that Broadcast Traffic Announcements:

1. Press the **BAND** button to select either the FM1, FM2 or FM3 radio band.
2. Press the **TRAF** button and the tuner will search for a station that broadcasts traffic announcements. "TA" will appear in the display. Once a station has been found "TP" will appear in the display and automatically start playing.
3. To search for another station that broadcasts traffic announcements press either the **◀◀** or **▶▶** button.
4. Press the **TRAF** button again to cancel this feature. "TA" will disappear from the display.

**Note:** The Traffic Announcement feature searches for stations that broadcast traffic announcements; it does not mean that they are presently broadcasting a traffic announcement.



Traffic Announcement      Traffic Program

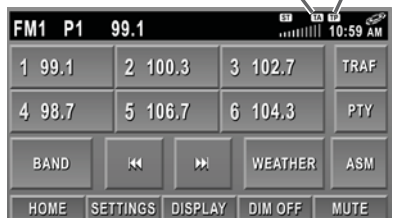

### Display Button:

Press the **DISPLAY** button repeatedly to display radio station's frequency, call letters or PTY type, if available.

**Note:** This feature is not available for AM frequencies.

### Display Information



## Weather Band Operation

### Power On/Off:

Press the  button to turn the unit On.

### Selecting the Weather Band Source:

Touch the **HOME** button to activate the source selection screen. Touch the **WEATHER** button to enter the weather band screen.

The weather band can also be accessed through the Radio screen. Touch the **WEATHER** button to enter the weather band screen.

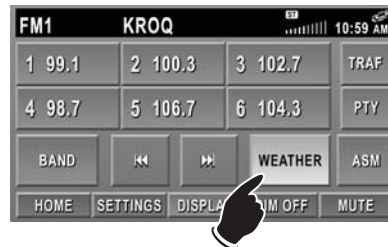
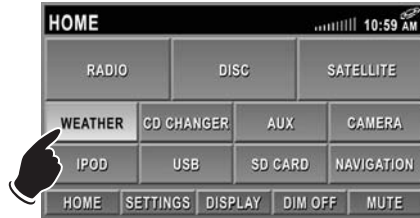

### Automatic Weather Band Station Tuning:

The strongest weather band station will automatically be selected and start playing.

#### Notes:

1. The remaining weather band stations will be stored in the Radio Station Recall buttons. Touch any of the Radio Station Recall buttons to select another weather band station.
2. To exit the weather band screen, touch the **BAND** button to select the AM/FM radio station screen or press the **HOME** button to select another source.

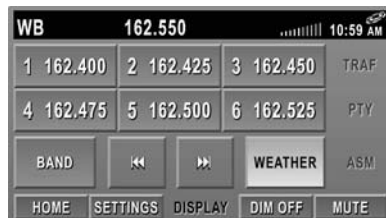

## Disc Warnings

### Disc Formats Supported by this Player:



**DVD**  
12cm disc  
(Single-sided disc only)



**CD**  
12cm disc



**MP3**  
12cm disc

### Handling:

- Dirt, dust, scratches and warping disc will cause non-operation.
- Do not place stickers on disc or scratch disc.
- Do not place discs in the following places: Direct sunlight, dirty, dusty or damp areas, near car heaters, car seats or dashboard.

### Disc Cleaning:

Use a dry, soft cloth to wipe the disc's surface. If the disc is very dirty, use a soft cloth slightly moistened with isopropyl (rubbing) alcohol. Never use solvents such as benzene, thinner or conventional record cleaners as they may mar the surface of the disc.

### Preparing New Discs with Rough Spots:

A new disc may have rough edges on its inside and outside edges. If a disc with rough edges is used, the proper setting will not be performed and the player will not play the disc. Therefore, remove the rough edges in advance by using a ball point pen or pencil as shown. To do this, press the side of the pen or pencil against the inside and outside edges of the disc.

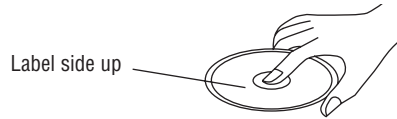

Do not touch the underside of the disc



Do not bend



Wipe the disc from the center toward the outside edge

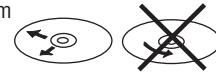

**Note:** A disc may become somewhat scratched (although not enough to make it unusable) depending on handling and conditions in the usage environment.

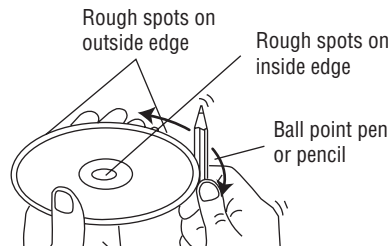

## CD Operation

### General Operations:

1. Press the button to turn the unit On.
2. Gently insert the disc into the slot with the label side up. The unit will automatically load the disc.

**Note:** If a CD does not auto-load, **DO NOT FORCE** it into the slot, as you may already have a CD loaded indicated by the inserted disc icon.

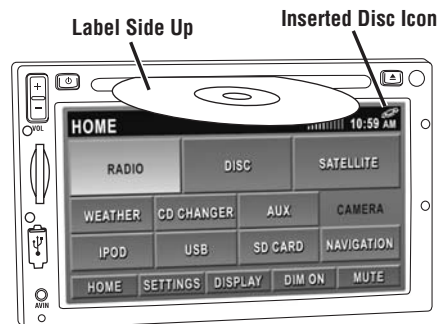

## CD Operation (Continued)

### Selecting the CD Source:

Press the **HOME** button to select the source screen. Next, press the **DISC** button to select the CD player.



### CD Track Selection:

Press the **⏮** button to select a lower track.  
Press the **⏭** button to select a higher track.

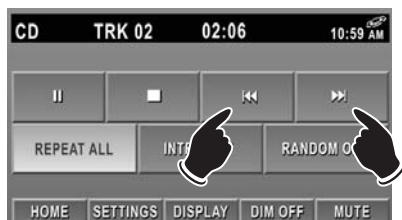

Lower  
Track

Higher  
Track

### Pausing a CD:

Press the **⏸** button to pause the disc. Press it again to resume play.

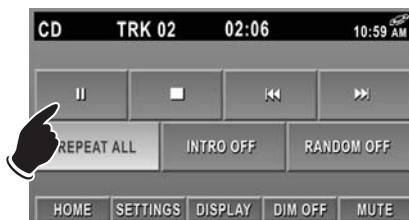

### Stopping a CD:

Press the **■** button to stop the disc. To resume play, press the **▶** button.

Press the **■** button 2 times, then press the **▶** button and the disc will start playing from the beginning.



### Ejecting a CD:

Press the **⏏** button to eject a disc.

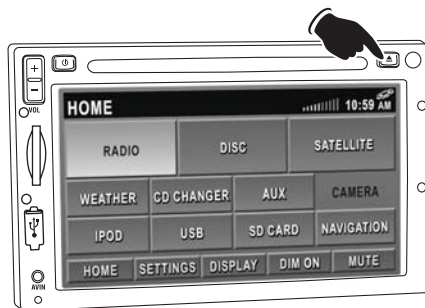

## CD Operation (Continued)

### Repeating a CD Track:

The M1-LCD's default setting is to repeat the disc. When the CD mode is selected, "REPEAT ALL" appears on the button and the entire disc will play and then continually replay.

To repeat a CD track, press the **REPEAT ALL** button until "REPEAT ONE" appears on the button. The CD track will now play repeatedly.

The repeat feature operates in the following sequence: Disc Repeat (REPEAT ALL) → Repeat Off (REPEAT OFF) → Track Repeat (REPEAT ONE) → Disc Repeat (REPEAT ALL) . . .



### Preview CD Tracks:

Press the **INTRO OFF** button until "INTRO ON" appears on the button. Each track on the disc will play for 15 seconds. To cancel this function, press the **INTRO ON** button until "INTRO OFF" appears on the button.



### Random CD Track Play Order:

Press the **RANDOM OFF** button until "RANDOM ON" appears on the button. The tracks on the disc will play in random order. To cancel this function, press the **RANDOM ON** button until "RANDOM OFF" appears on the button.

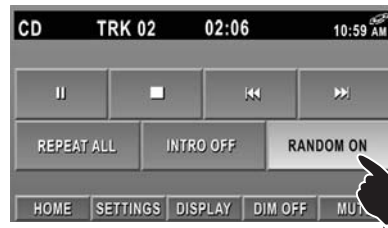

## MP3 Operation (Disc, USB and SD Card)

### Disc General Operations:

1. Press the **⏻** button to turn the unit On.
2. Gently insert the disc into the slot with the label side up. The unit will automatically load the disc.

**Note:** If a disc does not auto-load **DO NOT FORCE** it into the slot, as you may already have a disc loaded indicated by the inserted disc icon.

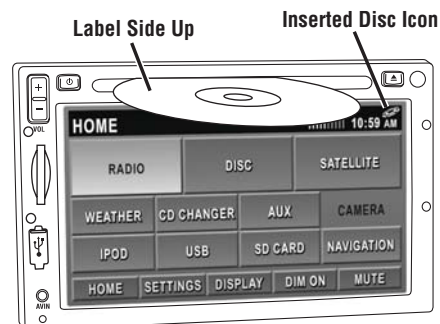

## MP3 Operation (Disc, USB and SD Card) (Continued)

### USB General Operations:

1. Press the  button to turn the unit On.
2. Pull back the rubber cover and insert the USB device or cable into the USB port. The playback source will change to USB operation and the Folder/Track panel will be displayed. Music playback will start automatically.

**Note:** USB devices and cables can only be inserted in one position. **DO NOT FORCE** it into the slot. Reverse the orientation and try to insert the device or cable again.

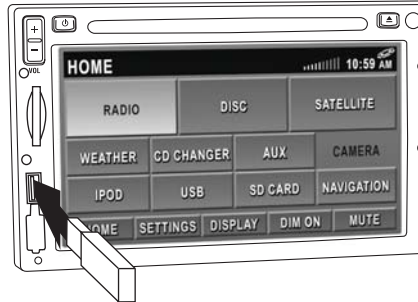

### SD Card General Operations:

1. Press the  button to turn the unit On.
2. Insert the SD Card into the SD card slot with the angle key up. The playback source will change to CARD operation and the Folder/Track panel will be displayed. Music playback will start automatically.

**Note:** SD cards can only be inserted in one position (angle key up). **DO NOT FORCE** it into the slot. Reverse the orientation and try to insert the SD card again.

### Angle Key

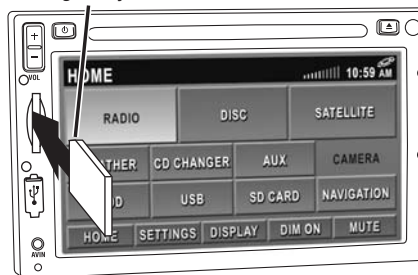

### Multiple Folder Selection:

If your MP3 media has multiple folders that contain music tracks, the Folder/Track panel will display "Folders" on the left side of the screen and "Music Tracks" on the right side of the screen. There are two methods to select folders.

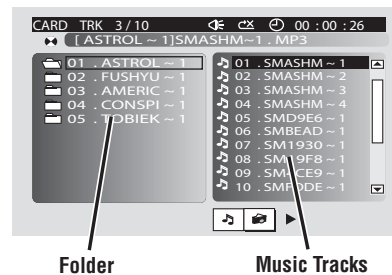

#### Method 1: Using the Touch Screen

Touch the screen to bring up the control button panel. Repeatedly press the  button to scroll down through "Music Tracks" in the first "Folder". Pressing the  button after the last music track in the first folder will select the first music track of the next folder.

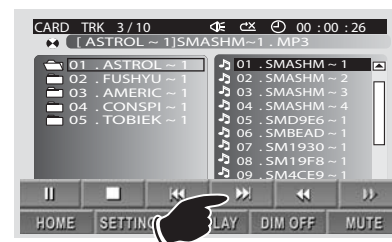



## MP3 Operation (Disc, USB and SD Card) (Continued)

### Multiple Folder Selection (continued):

#### Method 2: Using the Remote Control

1. Press the ◀ button and the current "Folder" in use will be highlighted.
2. Press the ▼ or ▲ button to scroll up and down through the folders.
3. Press the OK button to select the desired folder.
4. Press the ▶ button and the first "Music Track" will be highlighted.
5. Press the ▼ or ▲ button to scroll up and down through the music tracks on the screen.
6. Press the OK button to start playing the selected music track.

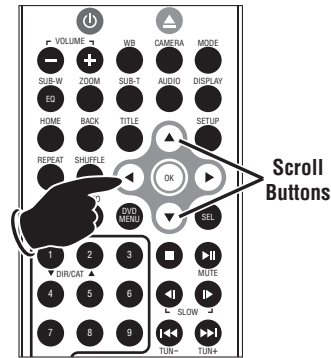

### Track Selection:

Touch the screen to activate the control button panel.

Press the ◀◀ button to select a lower track.

Press the ▶▶ button to select a higher track.

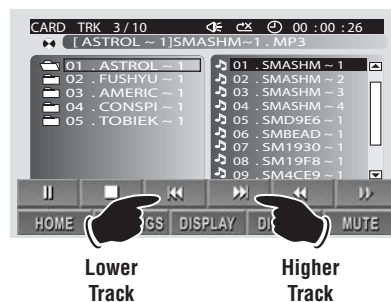

### Fast Forward / Fast Rewind:

Touch the screen to activate the control button panel.

Press the ◀◀ or ▶▶ button once to start the fast forward or fast rewind function speed of 2 times normal speed (X 2). Repeated pressing of the ◀◀ or ▶▶ button will increase the speed, X 4, X 8 and X 20. Touch the || button to resume normal MP3 playback.

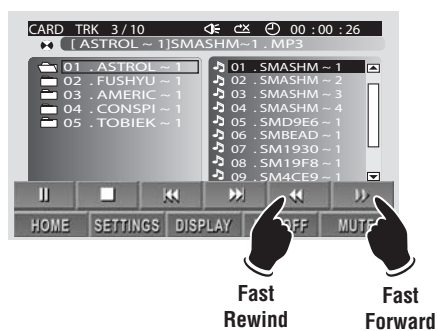

### Pause:

Touch the screen to activate the control button panel.

Press the || button to pause the disc. "PAUSE ||" will display and the button icon will turn to the ▶ "Play" icon. Touch the ▶ button to resume play.

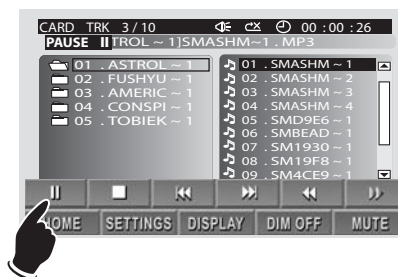



## MP3 Operation (Disc, USB and SD Card) (Continued)

### Stop:

Touch the screen to activate the control button panel.

Press the  button to stop play. To resume play, press the .

Press the  button 2 times, then press the  button and the first track from the first folder will start playing.

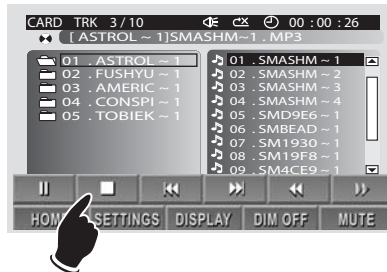

### Display:

Touch the screen to activate the control button panel.

Press the **DISPLAY** button for the following sequence: Detail Display with elapse time → Detail Display with time remaining → Detail Display off.

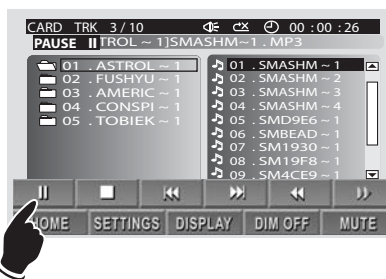

### Repeating a Track:

The repeat function can only be changed using the remote control. This function has 4 settings Repeat Off, Repeat Song, Repeat Directory and Repeat All. Press the **REPEAT** button on the remote control while watching the radio display panel for the setting indication.

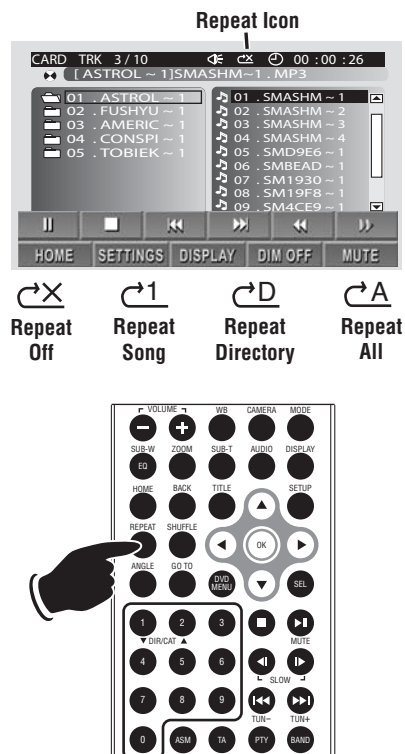

## MP3 Operation (Disc, USB and SD Card) (Continued)

### Random Track Play Order:

The random function can only be accessed by using the remote control. This function has 2 settings: On and Off. Press the **SHUFFLE** button on the remote control while watching the radio display panel for the setting indication.

### Random Indicator

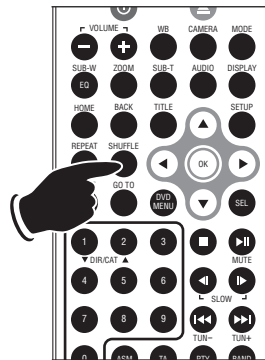
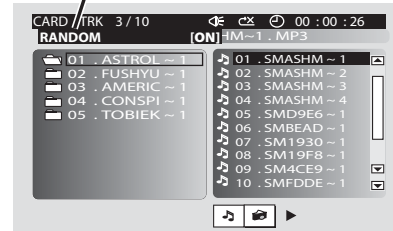

### Ejecting a Disc:

Press the  button to eject a disc.

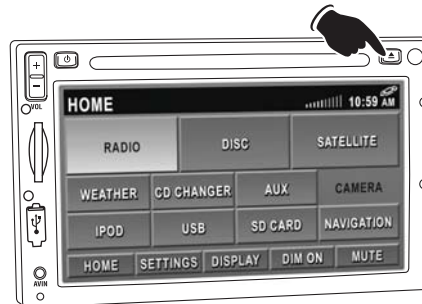

### Removing a USB Device or SD Card:

Remove a USB device or SD card at any time by pulling the device out of the socket.

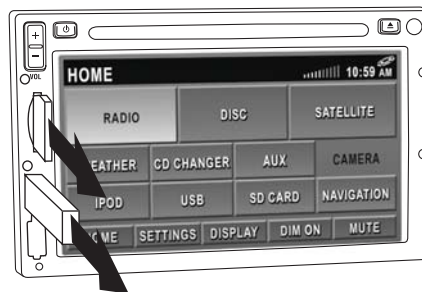

## DVD Operation (Continued)

### DVD General Operations:

1. Press the  button to turn the unit On.
2. Gently insert the DVD into the slot with the label side up. The screen will change to the DVD splash screen while the disc automatically loads.

**Note:** If a DVD does not auto-load, **DO NOT FORCE** it into the slot, as you may already have a disc loaded indicated by the inserted disc icon.

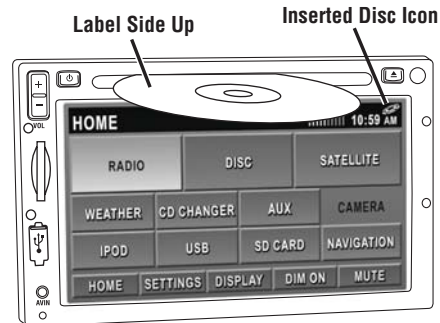

### Moving Vehicle Warning:

If the vehicle is moving, this screen will be displayed. The sound of the DVD can be heard. Once the vehicle is stopped and the parking brake is engaged, the video will play on the screen.



### Menu Screen:

Touch the screen to activate the DVD control button panel.

Press the **MENU** button to access the menu screen of the DVD.



### Navigation Buttons

Press the arrow buttons to navigate to the desired selection on the screen. Press the **ENTER** button to make the selection.

**Note:** Normally the "Play Movie" function is assigned to the **ENTER** button.



## DVD Operation (Continued)

### Pausing/Playing a DVD:

Touch the screen to activate the DVD control button panel.

Press the **II** button to pause the DVD disc. "PAUSE II" will appear in the display.

**Note:** The **II** "Pause" button has changed into a **▶** "Play" button.

To resume playing the DVD, press the **▶** button.



### Stopping a DVD:

Touch the screen to activate the control button panel.

Press the **■** button to stop play. To resume play, press the **▶** button.

Press the **■** button 2 times, then press the **▶** button and the DVD will start playing from the beginning.



### Selecting a Chapter:

Touch the screen to activate the DVD control button panel.

Press the **◀◀** button to select a previous chapter.

Press the **▶▶** button to select a next chapter.



Previous Chapter

Next Chapter

### Fast Forwarding / Fast Rewinding a DVD:

Touch the screen to activate the control button panel.

Press the **◀◀** or **▶▶** button once to start the fast forward or fast rewind function speed of 2 times normal speed (X 2). "FORWARD X 2 or BACKWARD X 2" will appear in the display. Repeated pressing of the **◀◀** or **▶▶** button will increase the speed, X 4, X 8 and X 20. Touch the **II** button to resume normal DVD playback.

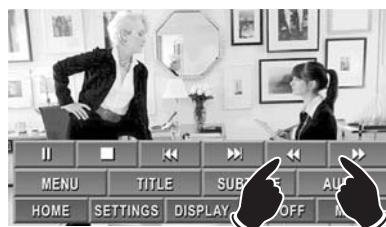

Fast Rewind

Fast Forward

## DVD Operation (Continued)

### Title Screen:

Touch the screen to activate the DVD control button panel.

The **TITLE** button functions differently depending on the characteristics of the DVD.

**Note:** In some DVDs, the Title function may be invalid. This is not a malfunction.



### Subtitle Language Menu:

Touch the screen to activate the DVD control button panel.

Press the **SUBTITLE** button during playback. Each time the button is pressed, the subtitle language changes in sequential order. The selection of subtitle appears at the top of the screen.

Notes:

1. Some discs may contain only one subtitle language.
2. Depending on the disc, the number of subtitle languages may be different.



### Audio Language:

Touch the screen to activate the DVD control button panel.

Press the **AUDIO** button during playback to select the desired audio/language setup. The audio languages to select from appear at the top of the screen.



### Ejecting a Disc:

Press the **EJECT** button to eject a disc.

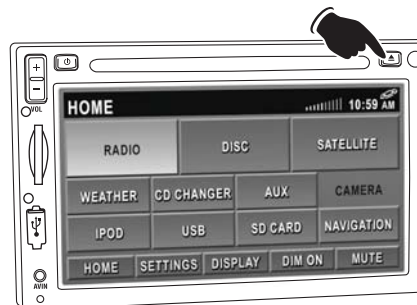

## DVD Setup Menu

**Note:** To access the DVD Setup Menu, a DVD disc has to be inserted.

### Accessing the DVD Setup Menu:

Press the **SETUP** button on the remote control to display the Setup Menu.

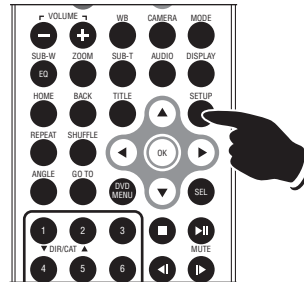

### System Setup



### Language Setup



### Audio Setup



### SYSTEM SETUP

TV SYSTEM

SCREEN SAVER

TV TYPE

PASSWORD

RATING

DEFAULT

EXIT SETUP

### System Setup Page:

Use the navigation buttons to scroll among the menu items. Make a selection by pressing the **OK** button.

- TV System: NTSC, PAL, Auto
- Screen Saver: On, Off
- TV Type: 4:3PS, 4:3LB, 16:9
- Password: \_ \_ \_ \_
- Rating: 1 Kid Safe  
2 G  
3 PG  
4 PG13  
5 PG-R  
6 R  
7 NC-17  
8 Adult
- Default: Restore
- Exit Setup

### Language Setup Page:

Use the navigation buttons to scroll among the menu items. Make a selection by pressing the **OK** button. Language Setup Options:

- OSD Language: English, German, Spanish, French, Portuguese, Italian, Russian
- Audio Lang: English, German, Spanish, French, Portuguese, Italian, Russian
- Subtitle Lang: English, German, Spanish, French, Portuguese, Italian, Russian, Off
- Menu Lang: English, German, Spanish, French, Portuguese, Italian, Russian, Off
- Exit Setup

### Audio Setup Page:

Use the navigation buttons to scroll among the menu items. Make a selection by pressing the **OK** button. Audio Setup Options:

- Downmix: LT/RT, Stereo, USS, 5.1 CH ON
- Key: #, +3, +2, 0, -2, -4, b
- Exit Setup

## Sirius Satellite Radio Setup (Option)

**Note:** The vehicle must be equipped with an optional Sirius tuner (SC-C1M) in order to receive a satellite signal. If the Sirius tuner is not activated, call 1-888-539-7474 to activate. The Sirius Tuner ID Number (SID) is required during the activation process. Follow the steps below to access the Sirius Tuner ID Number (SID):

### Accessing Your Sirius Tuner ID Number (SID):

1. From the Source Selection Screen press the **SATELLITE** button.



2. Press the **MENU** button.



3. Press the **DIRECT CH** button.



4. Press the **000** then press the **ENTER** button.

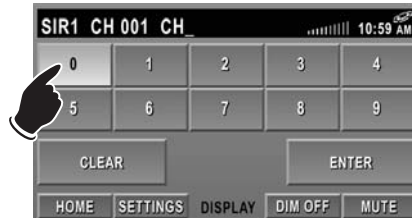

5. The Sirius Identification Number (SID) is located next to the "SONG TITLE" header.





## Sirius Satellite Radio Operation (Option)

Please note that satellite radio signal may be blocked by trees, buildings or other obstacles.

### Information display during reception:

**ANTENNA ERROR:** When an antenna issue exists.

**ACQUIRING SIGNAL:** When a channel is being tuned-in (no signal is yet received).

**INVALID CHANNEL:** A channel without a broadcast has been selected or the receiver may not be activated.

**CALL 888-539-SIRIUS TO SUBSCRIBE:** A channel not covered by your contract or the Sirius tuner is not activated. Call Sirius Service Center 1-888-539-7474 or visit them online at [www.siriusradio.com](http://www.siriusradio.com).

### Channel Selection Modes:

Channels are selected by the following methods:

- Manual Tuning: Use the Manual Tuning method to scan thru the channels.
- Direct Tuning: Use the Direct Tuning methods when you know the desired channel.
- Category Tuning: Use the Category Tuning method when you know what category you want to scan for a channel.

For details, see the following operation descriptions:

#### Manual Tuning:

Press the **CH -** or **CH +** button until the desired channel appears in the display.



#### Direct Tuning:

1. Press the **MENU** button.



2. Press the **DIRECT CH** button.



## Sirius Satellite Radio Operation (Option) (Continued)

### Direct Tuning (continued):

3. Press the numbers of the channel then press the **ENTER** button.

For example: For Sirius Channel 121, press **1**, **2** and **1** then press the **ENTER** button.

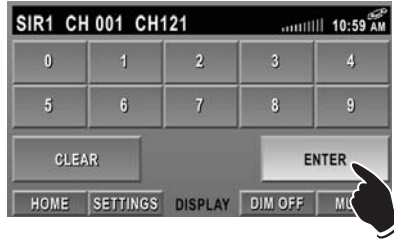

4. Once the **ENTER** button is pressed the channel will start playing.



### Category Tuning:

1. Press the **CATEGORY** button.



2. Use the **▲** or **▼** buttons to select the Category. The Category can also be selected by touching the desired category on the screen.

To select the Channel, use the **▲** or **▼** buttons. The channel can also be selected by touching the desired channel on the screen.

#### Category Channels within Category



3. Once the **ENTER** button is pressed, the channel will start playing.



## Sirius Satellite Radio Operation (Option) (Continued)

### Channel List:

1. Press the **CH LIST** button to access the Master Channel List menu.



2. Scroll through the channels by pressing the **▲** or **▼** button. When the desired channel is highlighted, press the **ENTER** button and the channel will start playing.



### Programming Preset Sirius Channel:

1. Tune in the desired Sirius channel then press the **PRESET** button to access the Preset Channel menu.

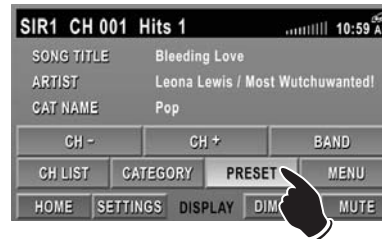

2. To program the channel, press and hold any one of the six channel recall buttons until you hear a beep. The preset number will now be displayed on the button and in the information display.

### Preset Number

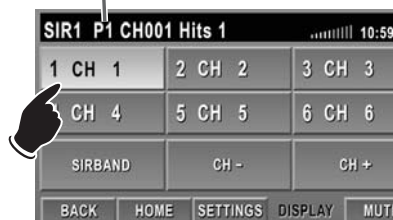

3. To program additional channels, tune them in using the **CH-** or **CH+** button. Press and hold any of the other five channel recall buttons until you hear a beep. The preset number will now be displayed on the button and in the information display.



Lower Channel      Higher Channel

## Sirius Satellite Radio Operation (Option) (Continued)

### Programming Preset Sirius Channel

(continued):

- Additional Sirius channels can also be programmed in the different Sirius Preset Bands (SIR1, SIR2 and SIR 3). Press the **SIR BAND** button to access the different Sirius Preset Bands.

**Note:** Each band can program 6 channels, so 18 Sirius channels can be programmed in the radio's memory.

### Preset Band

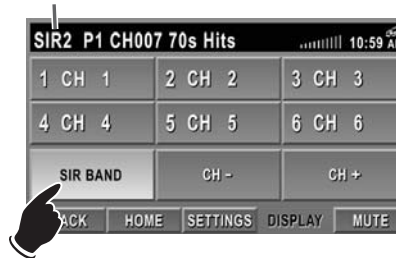

### Recalling Preset Sirius Channel:

- Press the **PRESET** button to access the Preset Channel menu.

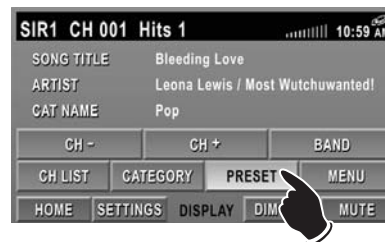

- To recall a Channel, press and release the preset number displaying the desired Channel number on the button.

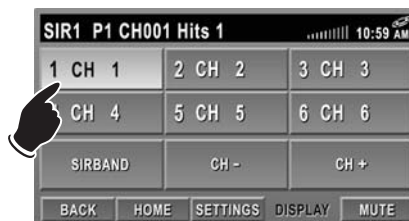

**Note:** Additional Sirius Channels can also be recalled in the different Sirius Preset Bands (SIR1, SIR2 and SIR 3). Press the **SIR BAND** button to access the different Sirius Preset Bands.

### Preset Band

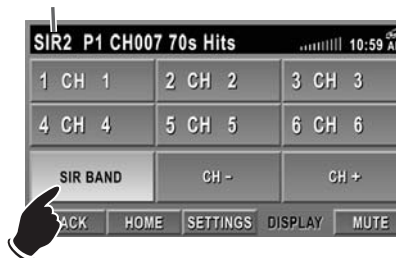

## Sirius Satellite Radio Operation (Option) (Continued)

### Skipping a Channel:

1. Press the **MENU** button.



2. Press the **SKIP CH** button.



3. Select the Channel by highlighting the Channel to be skipped and press the **SKIP** button. "SKIPPED" will appear next to the Channel.

### Channel Skipped Indicator



### Reinstating a Skipped a Channel:

Select the Channel to be reinstated by highlighting the Channel. "SKIPPED" will appear next to the Channel. Press the **UNSKIP** button and "SKIPPED" will disappear from the display. The Channel is now reinstated.



## CD Changer Operation (Option)

### Selecting the CD Changer Source:

Press the **HOME** button to select the source screen. Then press the **CD CHANGER** button to select the CD changer.



### Track Selection:

Press the **⏮** button to select a lower track.  
Press the **⏭** button to select a higher track.



Lower Track      Higher Track

### Pausing a Disc:

Press the **⏸** button to pause the disc. Press it again to resume play.



### Disc Selection:

Press the **DISC DOWN** button to select a lower disc in the CD changer.

Press the **DISC UP** button to select a higher disc in the CD changer.



Lower Disc

Higher Disc

## CD Changer Operation (Option) (Continued)

### Repeating a Track:

The M1-LCD's default setting is to repeat, in order, every disc in the CD Changer. "REPEAT OFF" appears on the button.

To repeat a track, press and release the **REPEAT OFF** button until "REPEAT TRACK" appears on the button. The track will now play repeatedly.

To repeat a disc, press and hold the **REPEAT OFF** button until "REPEAT DISC" appears on the button. The disc will now play repeatedly.

To cancel this function the button until "REPEAT OFF" appears on the button.



### Preview Tracks:

To preview tracks on a disc, press and release the **INTRO OFF** button until "INTRO TRACK" appears on the button. Each track on the disc will play for 10 seconds. To cancel this function, press the **INTRO TRACK** button until "INTRO OFF" appears on the button.

To preview the first tracks on every disc loaded in the CD Changer, press and hold the **INTRO OFF** button until "INTRO DISC" appears on the button. The first track on every disc will play for 10 seconds. To cancel this function, press the **INTRO DISC** button until "INTRO OFF" appears on the button.



### Random Track Play Order:

To play the tracks on a disc in random order, press and release the **RANDOM OFF** button until "RANDOM TRACK" appears on the button. The tracks on the disc will play in a random order. To cancel this function, press the **RANDOM TRACK** button until "RANDOM OFF" appears on the button.

To play all the tracks on every loaded disc in random order, press and hold the **RANDOM OFF** button until "random DISC" appears on the button. All the tracks on every disc will play in random order. To cancel this function, press the **RANDOM DISC** button until "RANDOM OFF" appears on the button.



## Auxiliary Audio Video Inputs Operation (Option)

**Note:** The M1-LCD will not control the auxiliary source, but can adjust the audio output. Refer to the audio device's owners manual for proper playback operation.

### Connecting an Auxiliary Audio/Video Device:

**Auxiliary Input 1:** Connect an auxiliary audio/video device using a 3.5mm jack (not supplied) into the socket mounted on the front of the unit.

**Auxiliary Input 2:** Connect an auxiliary audio/video device to the Auxiliary Input RCA connectors coming from the rear of the unit.

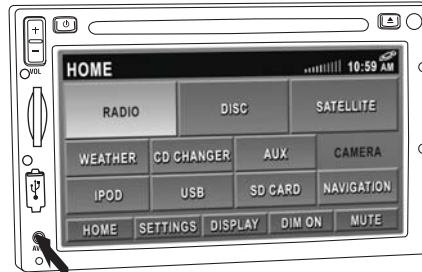

Auxiliary Audio/Video Input (3.5mm Jack)

### Selecting the Auxiliary Audio/Video Source:

Press the **HOME** button to select the source screen. Then press the **AUX** button to select the Auxiliary Audio/Video source.

**Note:** The M1-LCD will not control the auxiliary source, but can adjust the sound controls. Refer to the audio device's owners manual for proper operation.



### Moving Vehicle Warning:

If the vehicle is moving, this screen will be displayed. The sound of the source can be heard. Once the vehicle is stopped and the parking brake is engaged, the video will play on the screen.



### Menu Screen:

Press the **AUX 1/2** button to select the auxiliary source. The display will indicate which Auxiliary Source has been selected.

**Auxiliary Input 1:** Front Input.

**Auxiliary Input 2:** Rear Input.

**Note:** Touching the screen will activate the Home Row screen.

### Auxiliary Source Indicator





## Camera Operation (Option)

### Automatic Camera Selection:

#### Rear View Camera:

The rear view camera will automatically activate when the ignition key is turned "On" and the vehicle is put into reverse. The video image from the camera will appear on the screen and the audio from the rear camera only can be heard through the vehicle's speakers.

**Note:** This system only provides for one way audio, from the camera to the M1-LCD. **The M1-LCD is unable to transmit audio to the camera.**

#### Side View Cameras (Left and Right)(if equipped):

The side view cameras will automatically activate when the ignition key is turned "On" and the vehicle's turn signal are used. The video image from the camera will appear on the screen.

**Note:** Side view cameras do not have audio.

#### Front View Camera

The front view camera can not be automatically activated. The front view camera can only be manually selected, see "Manually Selecting the Camera View" below for more information.

**Note:** Front view camera does not have audio.

**Note:** Automatically activated camera views have priority over manually selected camera views. For instance: When a vehicle is put into reverse gear the rear camera view will automatically be displayed on the screen. A manually selected camera view can not override the rear camera view.

### Manually Selecting the Camera View:

1. Press the **HOME** button to select the source screen. Then press the **CAMERA** button to select the camera source screen.



2. Select a camera view (**FRONT**, **LEFT**, **RIGHT** or **REAR**) by pressing the button associated with the camera view you want to display on the screen.

**Note:** The front view camera may not be selectable depending if the system has a front view camera. If the system has a front view camera and is not available for selection go to "System Setup" (page 7) to activate the front camera.



Camera Views

### Rearview Camera (for motorized camera only):

If the rear view camera is motorized, there are two adjustment features available: tilt control and camera view presets. (Motorized cameras are not installed on all units).

#### Tilt Control:

Push the ▲ button to tilt the camera view up.  
Push the ▼ button to tilt the camera view down.

#### Camera View Presets:

To program a tilt viewing angle, press and hold either **PRESET A** or **PRESET B** button. To recall a programmed preset, press and release the button and the camera will automatically adjust.



Tilt Control  
Camera View Presets

## IPOD Operation (Option)

### General Operations:

1. Press the **⏻** button to turn the unit On.
2. Connect an IPOD to the cable attached to the M1-LCD.
3. The unit will automatically switch to the IPOD source screen and start playing.

**Note:** The controls on the IPOD will become inoperable and the M1-LCD will now control the IPOD.



### Selecting the IPOD Source:

Press the **HOME** button to select the source screen. Then press the **IPOD** button to select the IPOD source.

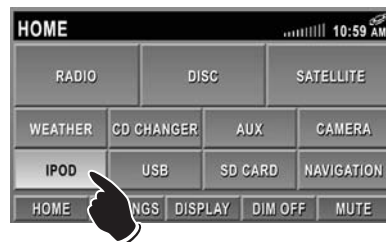

### IPOD Button Location and Functions:

1. **PTY Button:** Same operation as the MENU button on an IPOD.
2. **Previous and Next Buttons (⏮ and ⏭):** Press the ⏮ and ⏭ buttons to scroll through the menu items, same operation as the IPOD's Click Wheel.
3. **Play/Pause Button (⏮ ||):** Same operation as the ⏮ || button on an IPOD.
4. **ENTER Button:** Press the ENTER button for same operation as the Center Select button on an IPOD.

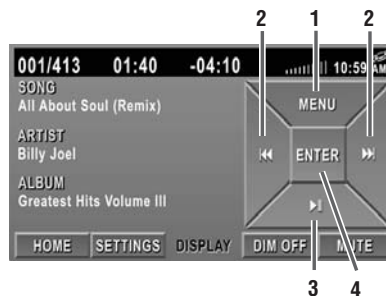

### Browse for a Song:

1. Press the **MENU** button until the screen containing PLAYLIST, ARTIST, ALBUM, GENRE and SONGS appears in the display.



2. Press the **SONGS** section of the menu.



## IPOD Operation (Option) (Continued)

### Browse for a Song (continued):

3. Press the **ENTER** button.



4. Press the ▲ or ▼ button to scroll through the songs.



5. Press the **ENTER** button and the song will start playing.



### Pausing a Track:

Press the ►|| button to pause the track. Press it again to resume play.

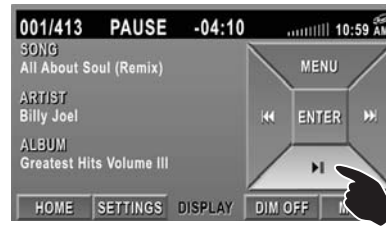

### Track Selection:

Press the ◀◀ button to select a lower track.

Press the ▶▶ button to select a higher track.

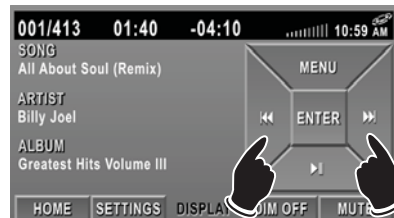

Lower Track Higher Track

## Navigation Operation (Option)

**Note:** Not all vehicles are equipped with an optional navigation system.

### Selecting the Navigation Source:

Press the **HOME** button to select the source screen. Then press the **NAVIGATION** button to select the navigation source.

**Note:** See Navigation Owner's Manual for operating instructions.

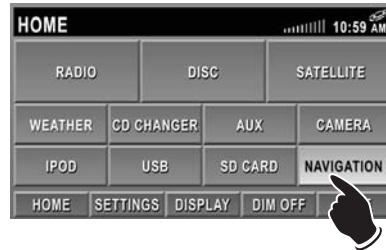

### Selecting a Different Source:

Press the  button to leave the navigation screen and return to the last selected source.

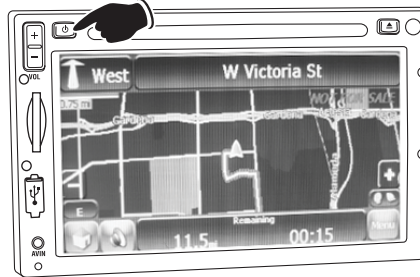

### Navigation Voice Control:

To access the Navigation Voice button, press the **SETTINGS** button in the home row, then press the **SOUND** button.

Turn the navigation voice on or off by touching the **NAVIGATION VOICE OFF/ON** button.

**Note:** If the optional navigation unit is not connected to the M1-LCD this button has no effect.

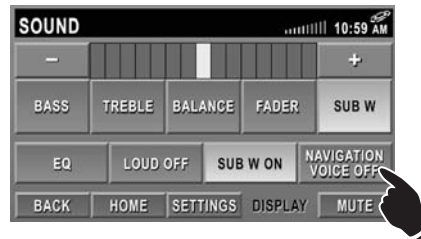

## Installation

- Step 1:** The radio chassis is designed to be "Sleeve Mounted" through an opening in the dashboard panel. The required opening size is 182mm (7-3/16") x 84mm (3-5/16"). Cut or engage an opening in the dashboard to accommodate the mounting sleeve.
- Step 2:** Insert the mounting sleeve into the opening in the dashboard. Bend the metal tabs on the sleeve to secure the mounting sleeve to the dashboard.
- Step 3:** Bring all wiring for the connection of the unit (including the antenna) through the center of the mounting sleeve.

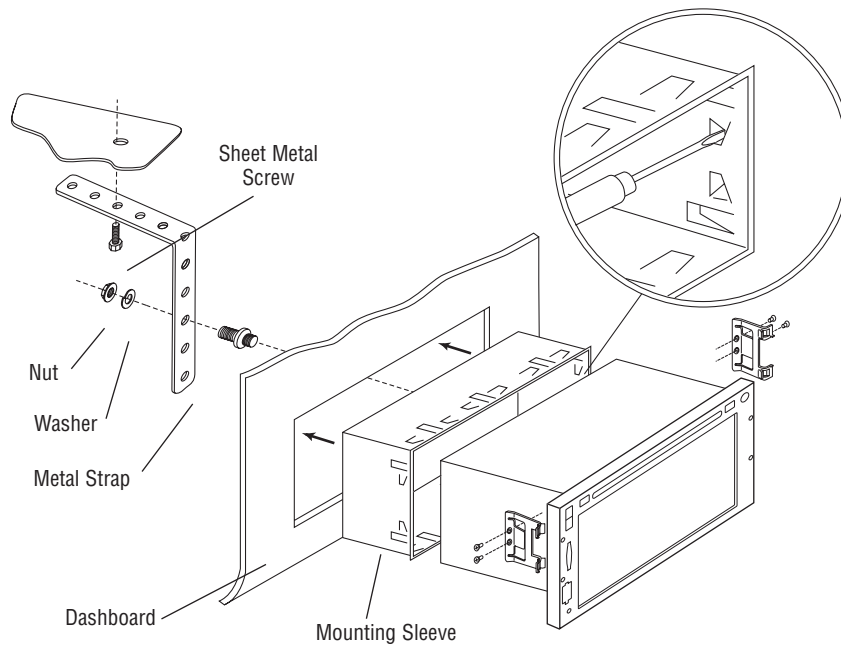

### Removing the Unit:

To remove the radio after installation, insert the removal keys straight back until they click. Then pull the radio out.

**Note:** If the removal keys are inserted at an angle they will not release the radio.

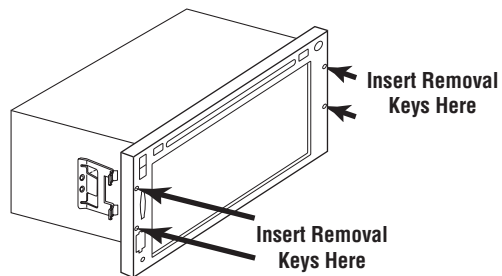

## Speaker Connections

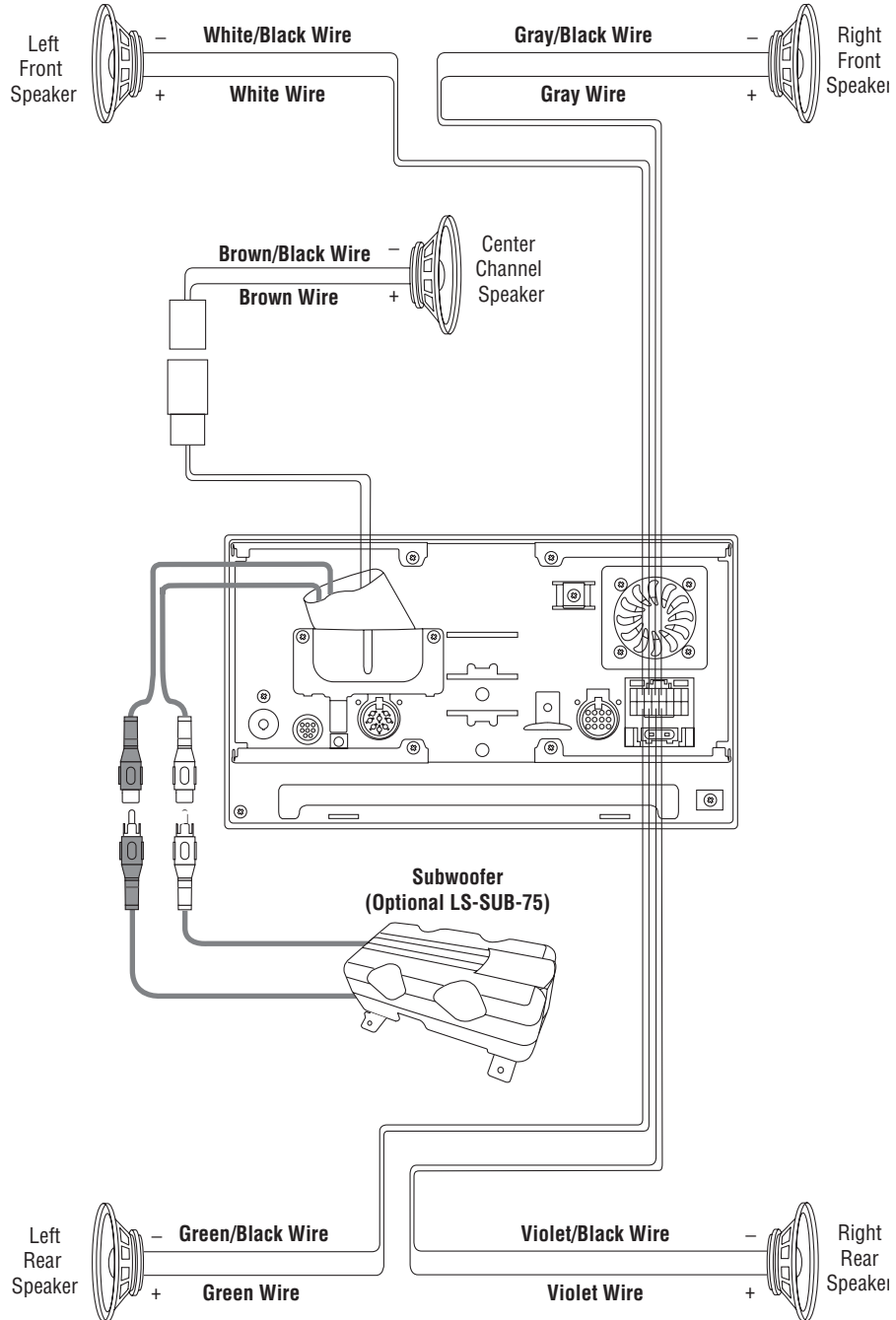

## Input Connections

This unit for use only with a 12 Volt DC power source with a negative ground.

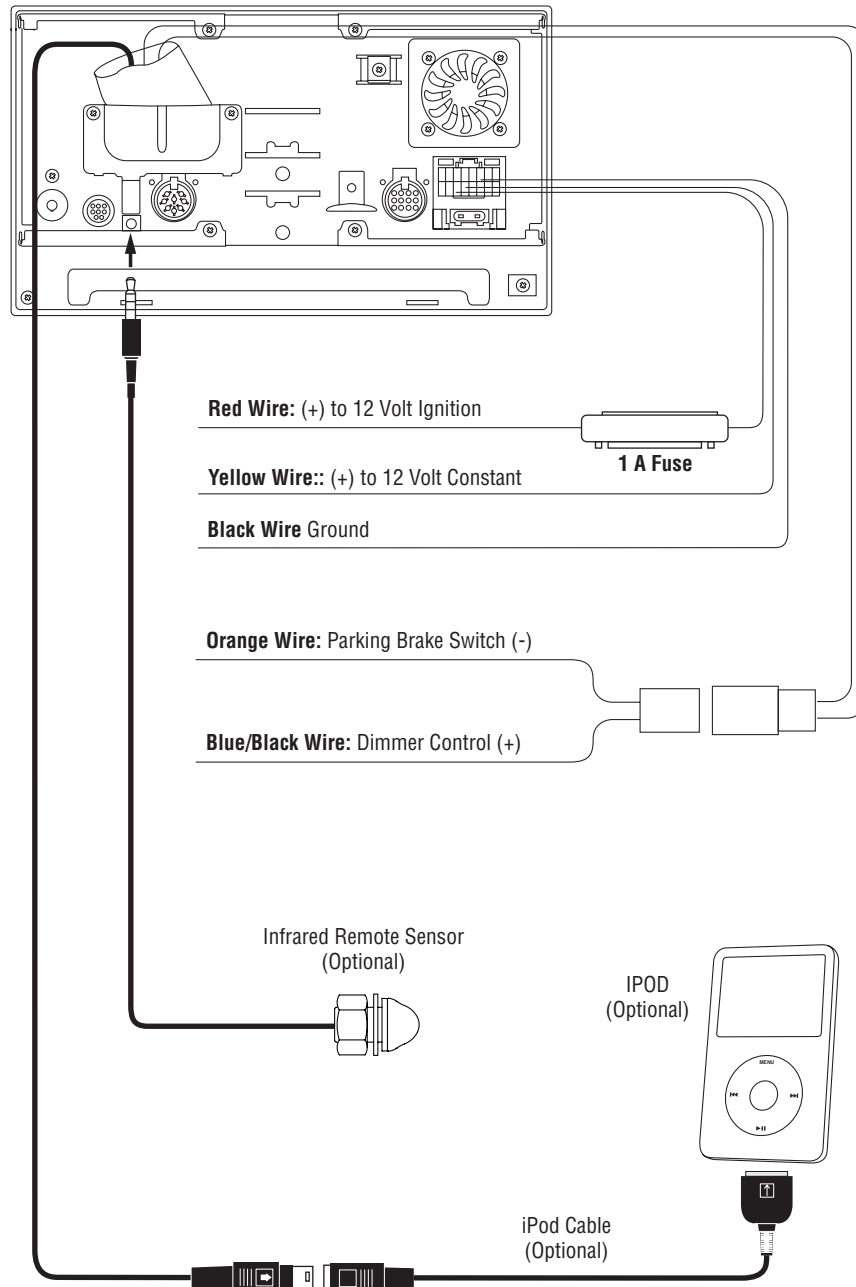

## Input Connections (Continued)

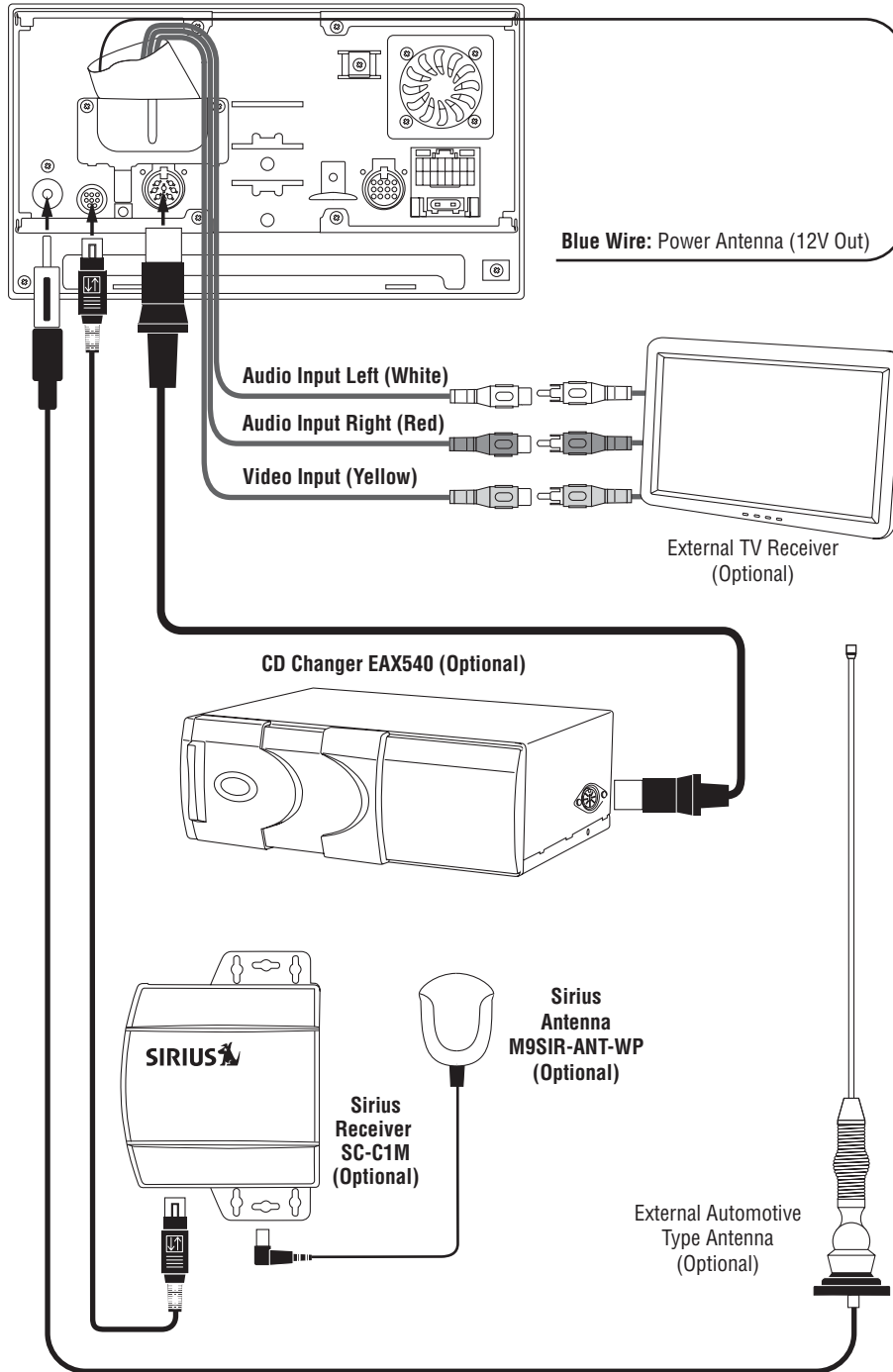



## Input/Output Connections (Continued)

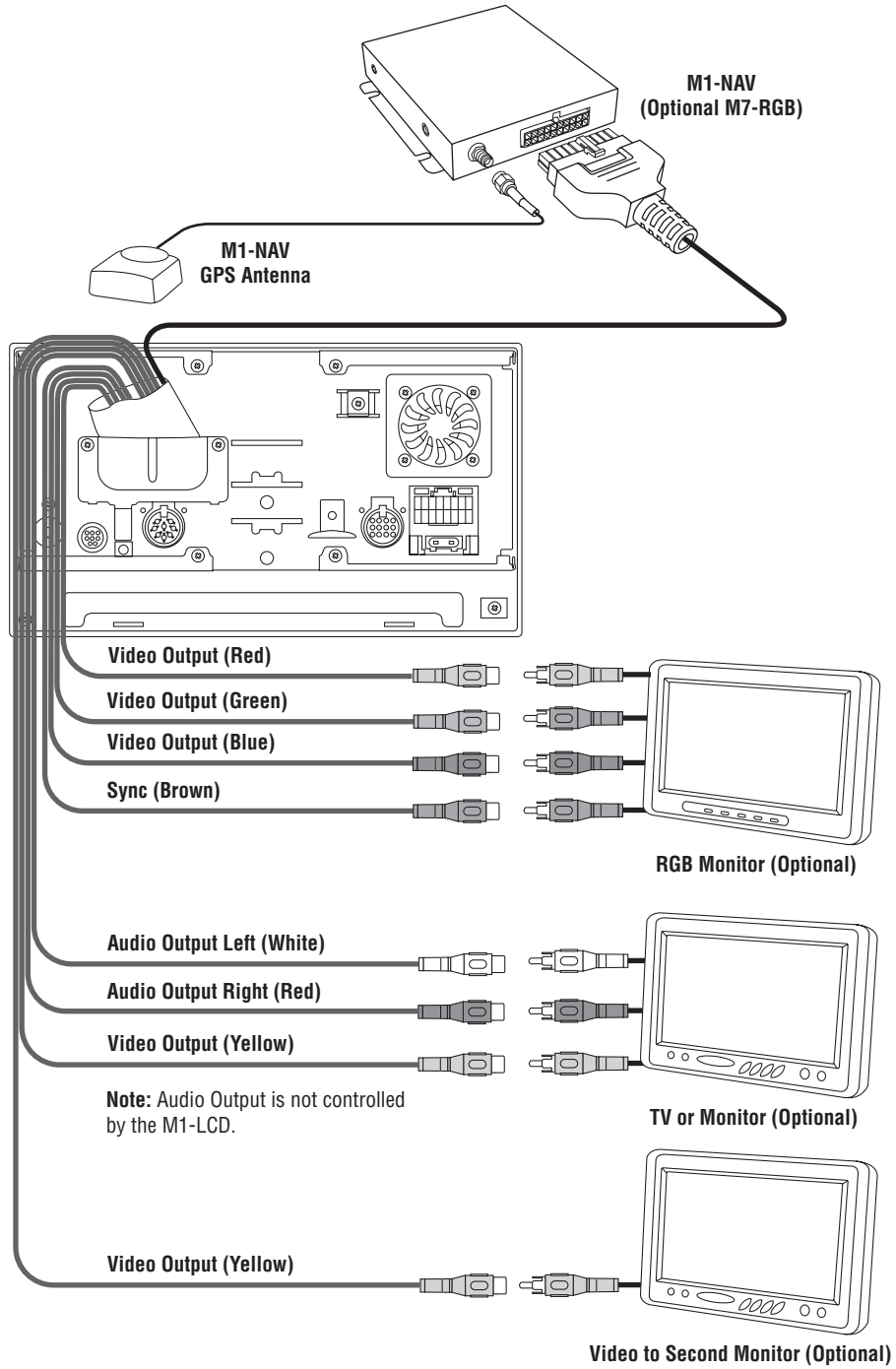

## Camera Connections (Continued)

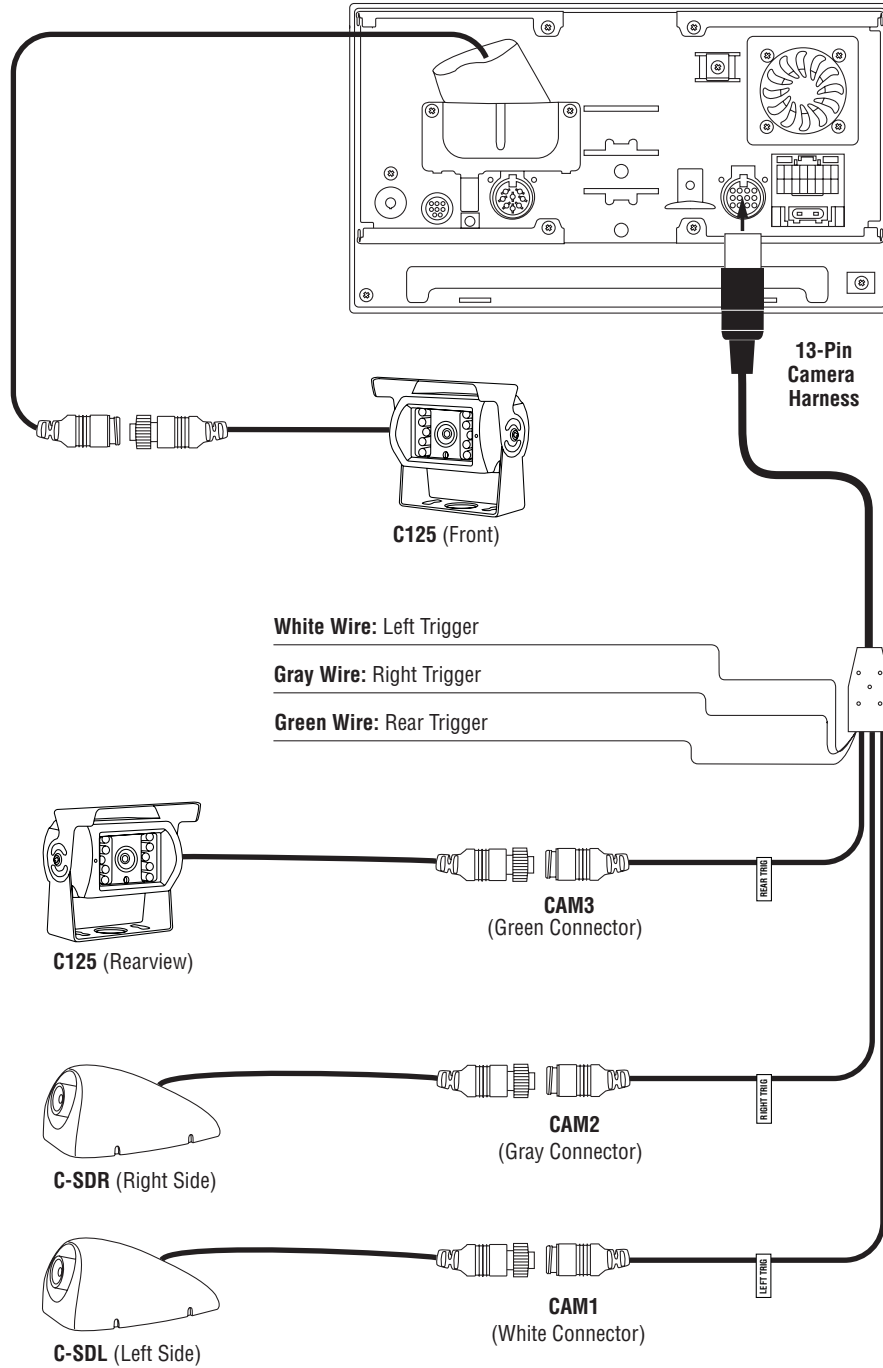

## Reset Button

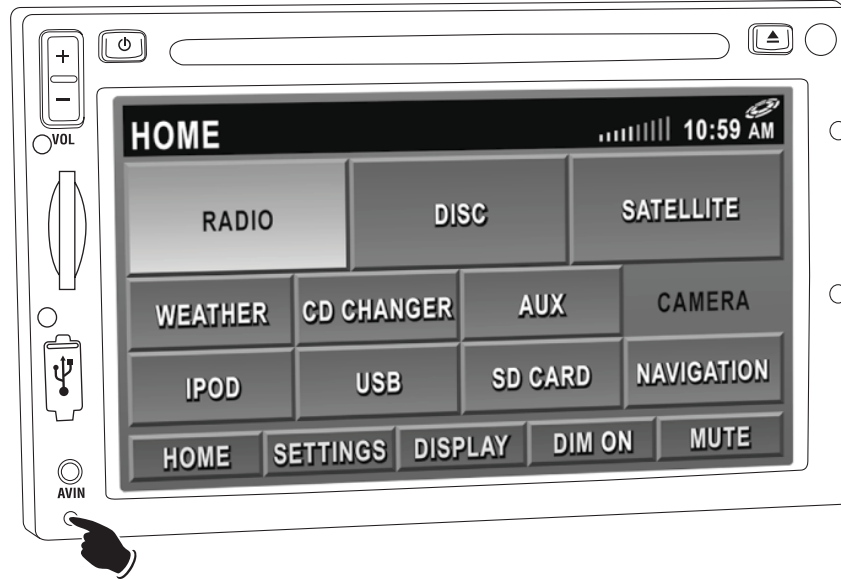

The LCD display may fail to function normally due to the vehicle's battery condition, and could require resetting the radio's microprocessor if:

- The vehicle has been "jump started" from a dead battery condition.
- The vehicle battery becomes very low and is quick-charged.
- The vehicle battery is removed and replaced.

Should any of these conditions occur, simply press and release the **RESET** button on the radio front panel using the tip of a ball point pen. This will reset the radio microprocessor to the original factory settings. After pressing the **RESET** button, you should recheck to see if the radio functions normally.

## Replaceable Fuse

If the fuse should blow, check that the wiring is correct. If the wiring is correct, replace the fuse with the same amperage rating as the original (15 amp).

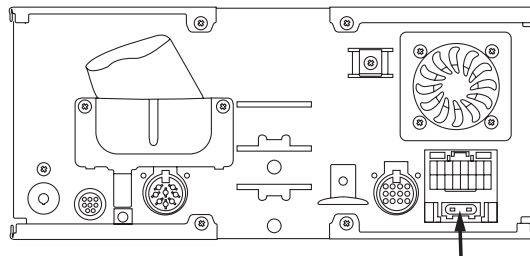

15 Amp Replaceable Fuse

## Warranty

### ONE (1) YEAR LIMITED WARRANTY

Magnadyne Corporation or its authorized agents will within one year from the date of sale to you, repair, replace or refund the retail sales price of said product or any part thereof, at the option of the Magnadyne Corporation or its authorized agents, if said product or part is found defective in materials or workmanship, when properly connected and operating on the correct power requirements designated for the specific product. This warranty and Magnadyne Corporation or its authorized agent's obligations hereunder do not apply where the product was; damaged while in the possession of the consumer, subjected to unreasonable or unintended use, not reasonably maintained, utilized in commercial or industrial operations, or serviced by anyone other than Magnadyne Corporation or its authorized agents, or where the warning seal on the product is broken or the power and/or plugs are detached from the unit. Magnadyne Corporation or any of its authorized agents will not assume any labor costs for the removal and reinstallation of any product found to be defective, or the cost of transportation to Magnadyne Corporation or its authorized agents. Such cost are the sole responsibility of the purchaser.

This warranty does not cover the cabinet appearance items or accessories used in connection with this product, or any damage to recording or recording tape, or any damage to the products resulting from improper installation, alteration, accident, misuse, abuse or acts of nature.

MAGNADYNE CORPORATION OR ITS AUTHORIZED AGENTS SHALL NOT BE LIABLE TO ANYONE FOR CONSEQUENTIAL OR INCIDENTAL DAMAGES OR CLAIMS EXCEPT THOSE ACCORDED BY LAW. NO EXPRESSED WARRANTY OR IMPLIED WARRANTY IS GIVEN EXCEPT THOSE SET FORTH HEREIN. NO IMPLIED WARRANTY SHALL EXTEND BEYOND ONE YEAR FROM THE DATE OF SALE.

This warranty extends only to the original purchaser of the product and is not transferable. Some states do not allow limitations on how long an implied warranty lasts, and some states do not allow the exclusion or limitation of incidental or consequential damages, so the above limitations or exclusion may not apply to you. This warranty gives you specific legal rights, and you may have other rights that vary from state to state.

**“NOTE: The manufacturer is not responsible for any radio or TV interference caused by unauthorized modifications to this equipment. Such modifications could void the User's authority to operate the equipment.”**

Defective merchandise should be returned to the original point of purchase or secondly, to Magnadyne Corporation, 1111 W. Victoria Street, Compton CA 90220.

Return Authorization must be obtained before sending, or merchandise may be refused.